

# WATERPROOF CONNECTORS

- **IP67 M12 CABLE JACKS**
- **3.4.5.8 PINS**
- **ASSEMBLY TYPE**
- **WP1203JA**
- **WP1204JA**
- **WP1205JA**
- **WP1208JA**

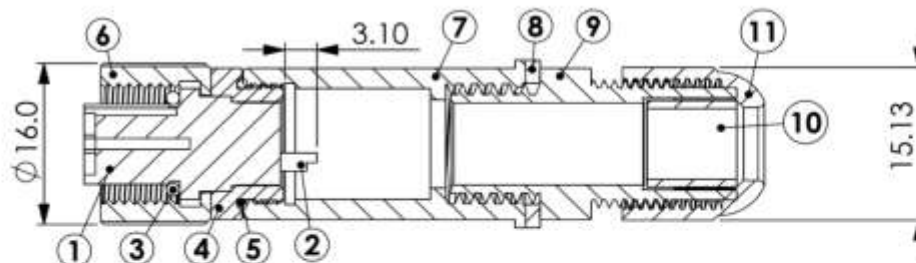



SECTION A-A

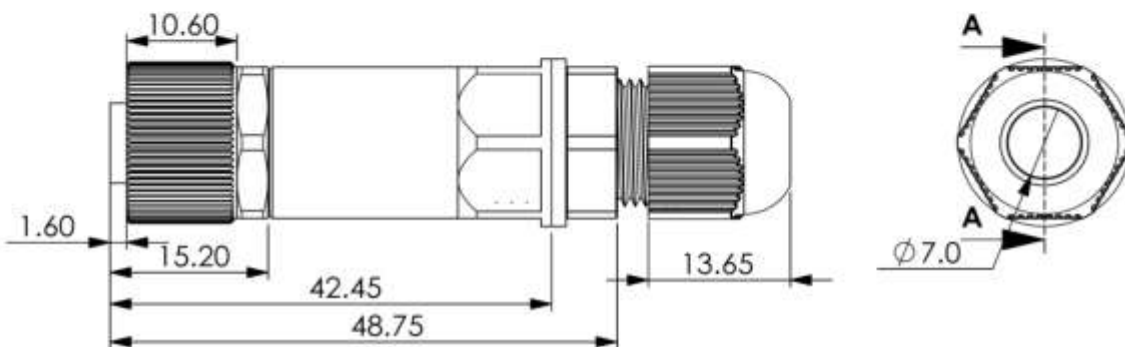
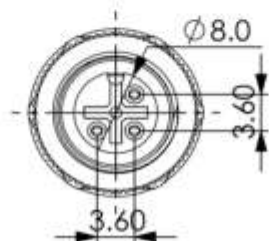

| No. | Description       | Material      | Treat       | Q'ty |
|-----|-------------------|---------------|-------------|------|
| 1   | 3P Housing        | Thermoplastic |             | 1    |
| 2   | Terminals         | Brass         | Gold Ptd.   | 3    |
| 3   | Rubber Ring       | NBR           |             | 1    |
| 4   | Housing Holder    | Brass         | Nickel Ptd. | 1    |
| 5   | O-Ring            | NBR           |             | 1    |
| 6   | Screw Cap         | Brass         | Nickel Ptd. | 1    |
| 7   | Shell Cover       | Brass         | Nickel Ptd. | 1    |
| 8   | WP Cable Holder B | NBR           |             | 1    |
| 9   | WP Cable Holder C | PA66          |             | 1    |
| 10  | WP Cable Holder D | NBR           |             | 1    |
| 11  | WP Cable Holder E | PA66          |             | 1    |

俞昌有限公司  
YEU TSANG CO. LTD.

品名: 3P M12 WATER TIGHT  
ITEM: CABLE JACK ASS'Y  
料號: WP1203JA  
PART NO: 圖號: DRW NO:



一般公差  
.X +/-0.25  
.XX +/-0.10

SHEET:  
1  
1

單位: mm  
unit: mm  
比例: 3:2  
scale:

日期: '07/01/23  
date:  
版本: V. 1.0  
version:

繪圖: DanielShyr  
drwn by:  
核准: SkyShyr  
aprvid by:

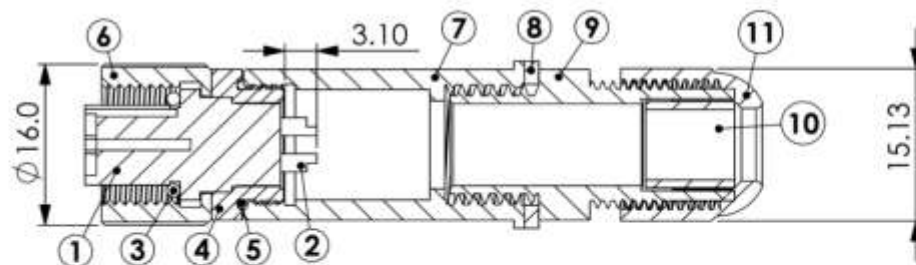

SECTION A-A

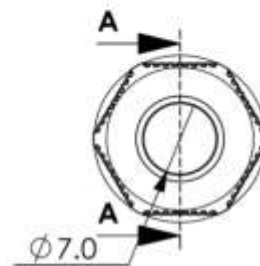
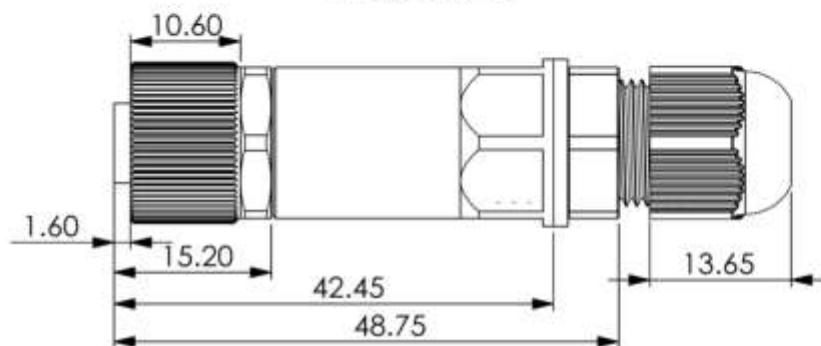
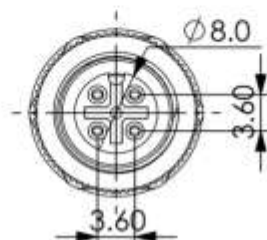

| No. | Description       | Material      | Treat       | Q'ty |
|-----|-------------------|---------------|-------------|------|
| 1   | 4P Housing        | Thermoplastic |             | 1    |
| 2   | Terminals         | Brass         | Gold Ptd.   | 4    |
| 3   | Rubber Ring       | NBR           |             | 1    |
| 4   | Housing Holder    | Brass         | Nickel Ptd. | 1    |
| 5   | O-Ring            | NBR           |             | 1    |
| 6   | Screw Cap         | Brass         | Nickel Ptd. | 1    |
| 7   | Shell Cover       | Brass         | Nickel Ptd. | 1    |
| 8   | WP Cable Holder B | NBR           |             | 1    |
| 9   | WP Cable Holder C | PA66          |             | 1    |
| 10  | WP Cable Holder D | NBR           |             | 1    |
| 11  | WP Cable Holder E | PA66          |             | 1    |

俞昌有限公司  
YEU TSANG CO. LTD.

品名: 4P M12 WATER TIGHT  
ITEM: CABLE JACK ASS'Y  
料號: WP1204JA  
圖號: [ ]  
PART NO: [ ]  
DRW NO: [ ]



一般公差  
.X +/0.25  
.XX +/0.10

SHEET:  
1  
1

單位: mm  
unit: mm  
比例: 3:2  
scale: 3:2

日期: '07/01/23  
date: '07/01/23  
版本: V. 1.0  
version: V. 1.0

繪圖: DanielShyr  
drwn by: DanielShyr  
核准: SkyShyr  
aprvd by: SkyShyr

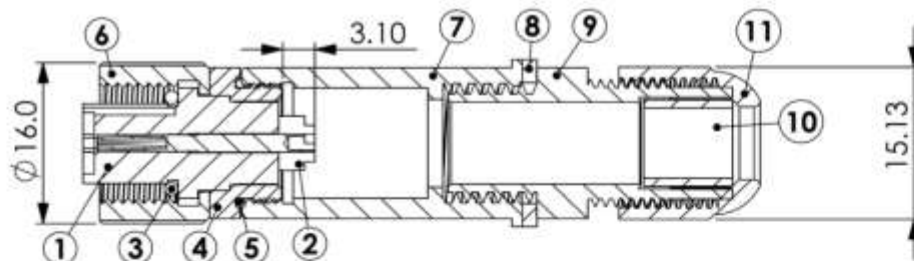

SECTION A-A

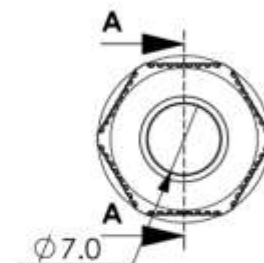
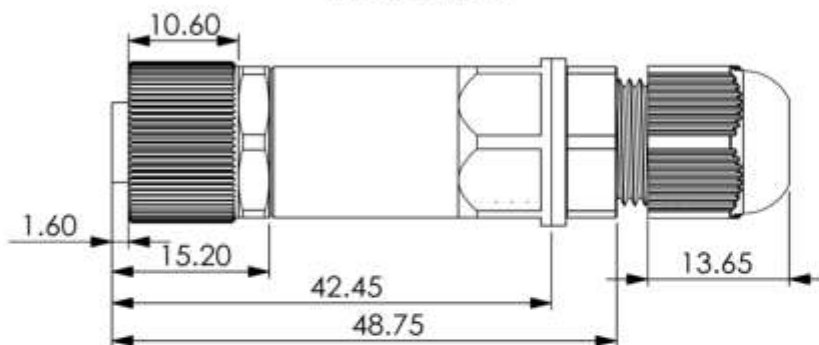
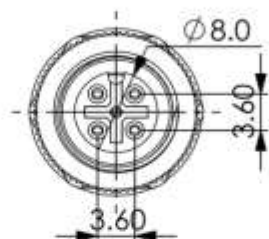

| No. | Description       | Material      | Treat       | Q'ty |
|-----|-------------------|---------------|-------------|------|
| 1   | 5P Housing        | Thermoplastic |             | 1    |
| 2   | Terminals         | Brass         | Gold Ptd.   | 5    |
| 3   | Rubber Ring       | NBR           |             | 1    |
| 4   | Housing Holder    | Brass         | Nickel Ptd. | 1    |
| 5   | O-Ring            | NBR           |             | 1    |
| 6   | Screw Cap         | Brass         | Nickel Ptd. | 1    |
| 7   | Shell Cover       | Brass         | Nickel Ptd. | 1    |
| 8   | WP Cable Holder B | NBR           |             | 1    |
| 9   | WP Cable Holder C | PA66          |             | 1    |
| 10  | WP Cable Holder D | NBR           |             | 1    |
| 11  | WP Cable Holder E | PA66          |             | 1    |

俞昌有限公司  
YEU TSANG CO. LTD.

品名: 5P M12 WATER TIGHT  
ITEM: CABLE JACK ASS'Y  
料號: WP1205JA  
PART NO:  
圖號:  
DRW NO:



一般公差  
.X  $\pm 0.25$   
.XX  $\pm 0.10$

SHEET:  
1  
1

單位: mm  
unit:  
比例: 3 : 2  
scale:

日期: '07/01/23  
date:  
版本: V. 1.0  
version:

繪圖: DanielShyr  
drwn by:  
核准: SkyShyr  
aprvid by:



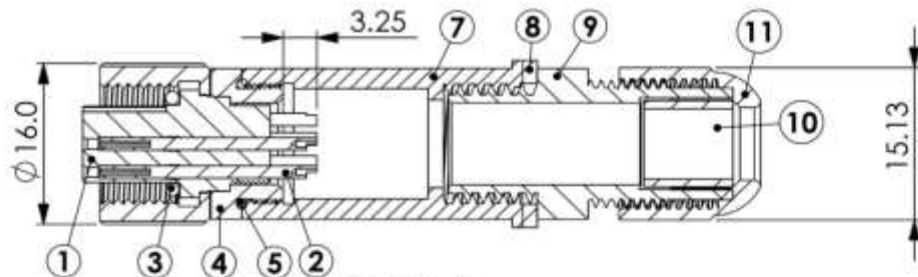
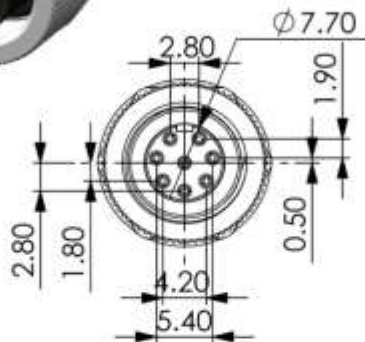

SECTION A-A

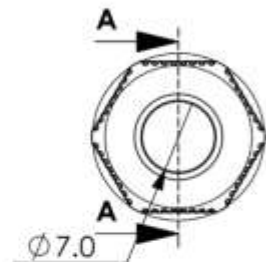
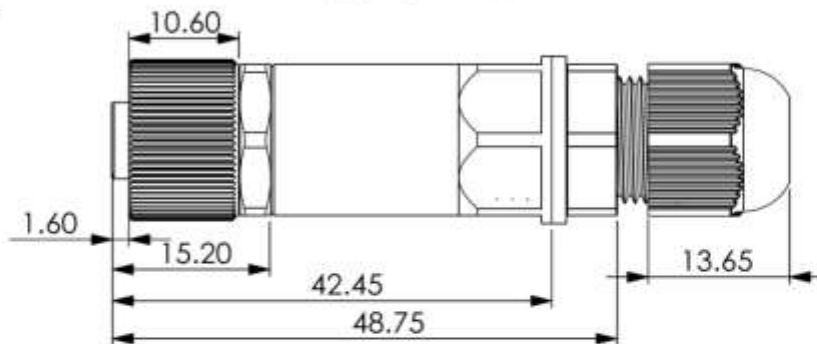

| No. | Description       | Material      | Treat       | Q'ty |
|-----|-------------------|---------------|-------------|------|
| 1   | 8P Housing        | Thermoplastic |             | 1    |
| 2   | Terminals         | Brass         | Gold Ptd.   | 8    |
| 3   | Rubber Ring       | NBR           |             | 1    |
| 4   | Housing Holder    | Brass         | Nickel Ptd. | 1    |
| 5   | O-Ring            | NBR           |             | 1    |
| 6   | Screw Cap         | Brass         | Nickel Ptd. | 1    |
| 7   | Shell Cover       | Brass         | Nickel Ptd. | 1    |
| 8   | WP Cable Holder B | NBR           |             | 1    |
| 9   | WP Cable Holder C | PA66          |             | 1    |
| 10  | WP Cable Holder D | NBR           |             | 1    |
| 11  | WP Cable Holder E | PA66          |             | 1    |

俞昌有限公司  
YEU TSANG CO. LTD.

品名: 8P M12 WATER TIGHT  
ITEM: CABLE JACK ASS'Y  
料號: WP1208JA  
PART NO:  
圖號:  
DRW NO.:



一般公差  
.X +/-0.25  
.XX +/-0.10



SHEET:  
單位: mm  
unit:  
比例: 3:2  
scale:

日期: '07/01/23  
date:  
版本: V. 1.0  
version:

繪圖: DanielShyr  
drwn by:  
核准: SkyShyr  
aprvid by: